



COMMERCIAL METAL PLANTERS

A DIVISION OF CODE ELECTRIC PRODUCTS LTD.

PRODUCT SPECIFICATION SHEET

09/17/21

PARTITIONS

- Material:** 0.125" marine grade 5052 aluminum
- Finish:** Durable, UV rated powder coat
- Colour:** Sterling Mocha Cloud
Slate Night Carbon
Tuscan Snow
- Drainage Holes:** Yes
No drainage holes available upon request
- Top Lip:** Standard 1" lip
** 1 1/2 lip with 1" return
+ stiffeners



Dimensions (in):

L	W	H
32	12	32
36	12	32
40	12	32
46	12	32
60	12	32**+
72	12	32**+
32	16	42**+
36	16	42**+
40	16	42**+
46	16	42**+
60	16	42**+
72	16	42**+

Weights

lbs	kg
40	18
43	20
47	21
53	24
66	30
77	35
56	25
61	28
66	30
74	34
91	41
106	48

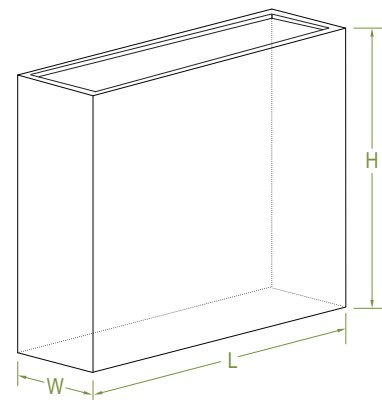
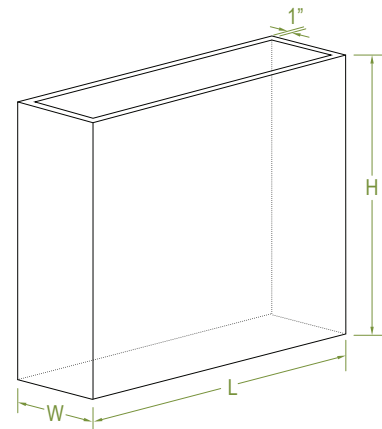

Custom sizes available upon request

Project:	
Company Name:	
Contact Name:	
Date:	
Approval Signature:	