



COMMERCIAL METAL PLANTERS

A DIVISION OF CODE ELECTRIC PRODUCTS LTD.

PRODUCT SPECIFICATION SHEET

09/17/21

CUBES

Material: 0.125" marine grade 5052 aluminum

Finish: Durable, UV rated powder coat

Colour:

Sterling	Mocha	Cloud
Slate	Night	Carbon
Tuscan	Snow	

Drainage Holes: Yes
No drainage holes available upon request

Top Lip: Standard 1" lip

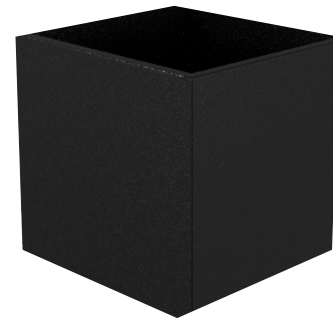

Dimensions (in):

L	W	H
16	16	16
20	20	20
24	24	24
28	28	28
36	36	36

Weights

lbs	kg
16	7
25	11
36	16
49	22
81	36

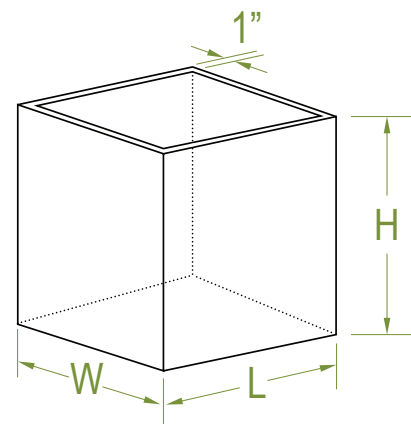

*Can also be fabricated without a lip
Custom sizes available upon request

Project:	
Company Name:	
Contact Name:	
Date:	
Approval Signature:	